

Georgia's Plan & Procedures

FY2021 Office for Civil Rights (OCR)/Methods of Administration (MOA) Compliance Review Handbook

Georgia Department of Education
Career, Technical and Agricultural Education
Revised February 2020

TABLE OF CONTENTS

I. INTRODUCTION	4
▪ Mission	
▪ Goal	
▪ Objectives	
▪ Accountability = Credibility	
▪ Federal Laws for Civil Rights & Resources	
▪ Special Populations Defined	
▪ Steps in the Process	
▪ Targeted Schools	
II. THE FOCUS OF AN OCR/MOA COMPLIANCE REVIEW	7
<i>Areas of Investigation</i>	
▪ Administration	
Notice – (USDE Nondiscrimination Statement)	
-Annual	
-Continuous	
▪ Site Location and Student Eligibility Criteria	
▪ Recruitment	
▪ Admissions Criteria	
▪ Student financial Assistance	
▪ Career Counseling Programs	
▪ Services for Students with Disabilities	
▪ Accessibility	
▪ Comparable Facilities	
▪ Work Study, Cooperative Ed, Job Placement, Apprenticeship	
▪ Employment of Faculty and Staff	
III. Getting Ready for the Visit.....	10
▪ Systems Contact Persons	
▪ Ready for Review	
IV. PREPARING FOR THE VISIT	11
▪ Identify Staff Team Members	
▪ Develop OCR/MOA Visit Agenda - Appendix A	
▪ Complete Compliance Review Self-Assessment – Appendix B	
▪ Schedule Interview Teams	
▪ Complete Facility Accessible Assessment – Appendix C	
V. Prepare Documentation Notebook.....	11
▪ Administrative Compliance	
▪ Site Location and Student Eligibility	
▪ Recruitment Issues	
▪ Admissions Issues	

- **Student Financial Assistance Issues**
- **Counseling Issues**
- **Services for Student with Disabilities**
- **504/ADA Accessibility Issues**
- **Comparable Facilities Issues**
- **Work Study/Apprenticeship**
- **Employment Issues**

VI. APPENDICES.....14

- **Appendix A-Sample OCR/MOA Review Agenda**
- **Appendix B-OCR/MOA Compliance Review Self-Assessment**
- **Appendix C-Facility Accessible Self-Assessment**
- **Appendix D-Continuous and Annual Discrimination Statement plus Contribution**
- **Appendix E - Sample 1**
- **Appendix F - Sample 2**
- **Appendix G - Sample 3**
- **Appendix H – Frequently Asked Questions**
- **Appendix I – Voluntary Compliance Plan (VCP)**
- **Appendix J – Sample Floor Plan**
- **Appendix K – Student/Instructor Demographic**

FY2021 CTAE Methods of Administration (MOA) Office for Civil Rights (OCR) Compliance Review

I. INTRODUCTION

THE MISSION

To ensure equitable distribution of federal vocation education funds and to encourage high-quality Career, Technical and Agricultural Education (CTAE) programs, the U.S. Department of Education Office for Civil Rights requires the local agency to conduct compliance reviews of the state's CTAE programs. "The mission of the U.S. Department of Education Office for Civil Rights is to ensure equal access to education and to promote educational excellence throughout the nation through vigorous enforcement of civil rights."

GOAL

Participants from targeted school will have a better understanding of the Methods of Administration which ensures the equitable distribution of federal vocational education funds and encourages high-quality Career, Technical and Agricultural programs.

OBJECTIVES

- To review the legislation
- To review the procedure for targeting
- To review the areas of investigation and suggested documentation for evidence
- To review the procedure and processes

MORE ACCOUNTABILITY = GREATER CREDIBILITY

- **Perkins Compliance Review**
 - Required by Perkins
 - Conducted with 1/5 systems per year
 - Serves as a mechanism for evaluation both internally and externally
 - Provides professional learning for team members
- **MOA Compliance Review**
 - Required by Office for Civil Rights
 - Conducted in 5 systems per year targeted from the 1/5 systems
 - Serves as a mechanism for evaluation both internally and externally
 - Provides professional learning for team members

FEDERAL LAWS FOR CIVIL RIGHTS AND RESOURCES

Federal law requires that all school districts receiving federal funding support from the U.S. Education Department, and providing career, technical and agricultural education programs shall comply with:

THE CIVIL RIGHTS ACT OF 1964, TITLE VI:

No person in the United States shall, on the ground of race, color, or national origin, be excluded from, be denied the benefits of, or be subjected to discrimination under any program or activity receiving Federal financial assistance.

THE REHABILITATION ACT OF 1973, SECTION 504:

No otherwise qualified handicapped individual...shall, solely by reason of his or her handicap, be excluded from the participation in, be denied the benefits of, or be subjected to discrimination under any program or activity receiving Federal financial assistance.

THE EDUCATION AMENDMENTS OF 1972, TITLE IX:

No person...shall, on the basis of sex, be excluded from participation in, be denied the benefits of, or be subjected to discrimination under any education program or activity receiving Federal financial assistance.

THE AMERICAN WITH DISABILITIES EDUCATION ACT OF 1990, TITLE II:

An act to establish a clear and comprehensive prohibition of discrimination based on disability.

Vocational Education Program Guidelines for Eliminating Discrimination and Denial of Services on the Basis of Race, Color, National Origin, Sex, and Handicap. Federal Register, March 21, 1979.

School districts have been selected for on-site review and technical assistance based on a federally approved targeting plan. Ongoing compliance with civil rights statutes is required by the U.S. Department of Education Office for Civil Rights, regardless of whether your school district receives an onsite review. Federal civil rights regulations and guidelines can help us to provide each student with greater opportunities to achieve high academic standards, and to eliminate the achievement gap at state and local levels.

Please carefully review the enclosed materials. We will be pleased to work you and your staff at any time, and to offer our assistance as you work to enhance student learning for all students. You may contact Dr. Ray Anukam 404-657-6589 or ranukam@doe.k12.ga.us .

SPECIAL POPULATIONS DEFINED

- **Students w/ Disabilities**
- **Students w/ Limited-English Proficiency**
- **Displaced Homemakers**
- **Individuals from Economically Disadvantaged Families**
- **Individuals Preparing for Non-traditional (fields) Training & Employment**
- **Economically Disadvantaged Students, Including Foster Children**
- **Single Parents & Single Pregnant Women**
- **Individuals with Other Barriers to Educational Achievement**
- **Individuals in State Institutions**

STEPS IN THE REVIEW PROCESS

- ✓ *Superintendent receives MOA letter*
- ✓ *MOA workshop for “targeted systems”*
- ✓ *Collect evidence and documentation for all required areas*
- ✓ *Organize into notebook*
- ✓ *Submit electronic requested information*
- ✓ *OCR/MOA Team Visit*
- ✓ *Interviews: Parents, students, instructors, 504 coordinator, Title IX coordinator, Exceptional Children’s coordinator, administration and counselors asking probing questions to verify compliance.*
- ✓ *Walk through of the facilities including building entrances, CTAE lab areas including greenhouse, common areas like cafeteria, and shower and dressing room facilities to determine accessibility and equality*
- ✓ *Review documents requested as evidence to verify compliance; organized in folders by areas of investigation (combine work study and apprenticeship)*
- ✓ *Brief exit report of any major finding(s)*
- ✓ *Written report (letter of finding(s) – LOF) sent to the Superintendent within 6 weeks after the visit*
- ✓ *System is responsible for a voluntary compliance plan (VCP) within 4 weeks of receiving the letter of finding(s)*
- ✓ *State recipient must submit a biennial report of all review findings and voluntary compliance plans*
- ✓ *System is responsible for a voluntary compliance plan (VCP) within 4 weeks of receiving the letter of finding(s)*
- ✓ *State recipient must submit a biennial report of all review findings and voluntary compliance plans*

TARGETED SCHOOLS FY2021

Questions regarding the selection of schools/systems, please contact Ray Anukam at ranukam@doe.k12.ga.us.

2020-2021 Systems

1. Dalton Public Schools – September 2, 2020
2. Dougherty County Schools – August 18, 2020
3. Gainesville City Schools – August 25, 2020
4. Marietta City Schools – August 25, 2020
5. Muscogee County Schools – August 20, 2020

II. THE FOCUS OF AN OCR/MOA COMPLIANCE REVIEW

The Office for Civil Rights compliance review is focused on the following *Areas of Investigation*:

ADMINISTRATION

Recipients must take continuing steps to notify students, applicants, parents, employees, and unions or professional organizations that it does not discriminate based on race, color, national origin, sex, or disability (Appendix D).

1. Prior to the beginning of the school year annually, recipient must advise students, parents, employees, and the general public that ALL CTAE program opportunities will be offered to all students regardless of race, color, national origin, sex, or disability (Appendices E & F).
2. Each recipient must designate at least one qualified employee to coordinate its efforts to comply with and carry out its responsibilities under Section 504, Title II and Title IX. The recipient must notify students, staff, and the public of the name, address, and phone number of designated employee(s).
3. A recipient shall adopt and publish a grievance procedure providing for prompt and equitable resolution of student and employee complaints alleging discrimination based on sex, race, color, national origin, or disability.

SITE LOCATION AND STUDENT ELIGIBILITY CRITERIA

1. A recipient may not select CTAE facilities building sites or renovations, residency requirements, student numerical limits, or other criteria that could result in disproportionately excluding students of certain race, color, national origin, sex, or disability.

RECRUITMENT

1. Recruitment activities must not exclude individuals or limit opportunities based on sex, race, color, national origin, or disability.
2. Recruitment materials must not contain biased or stereotypical contents.
3. Recruiting teams should, to the extent possible, represent diverse populations.
4. Recipients must ensure that counselors can communicate with limited English proficient populations and persons with sensory impairments.
5. Recruitment materials must be available to communities of minority-language speakers in their languages.

ADMISSIONS CRITERIA

1. A recipient may not assess candidates for admission to CTAE programs based on race, color, national origin, sex, or disability.
2. A recipient must avoid preadmission inquiries about marital, parental, pregnancy, or disability status.
3. Recipients may not deny access to any CTAE program to students with a disability on the basis that employment opportunities may be limited.
4. Recipients may not restrict admission to CTAE programs based on English language proficiency.
5. Recipients must have policies and procedures in place for identifying and serving limited English proficient students.

STUDENTS FINANCIAL ASSISTANCE

1. Recipients are not to limit honors, awards, and scholarships to a group on the basis of race, color, national origin, sex, or disability unless such targeting is done to provide opportunities to members of a group that has not traditionally been represented. Outside agencies that provide awards are to be notified of the district's nondiscrimination policy.
2. A recipient may administer or assist in the administration of scholarships, fellowships, or other forms of financial assistance established pursuant to domestic or foreign will trust, bequests, or similar legal instruments or by acts of a foreign government which require that awards go to a student of a particular sex, race, or national origin, or with a student with a particular disability.
3. To meet this requirement, a district must implement a review process and keep records for no less than 5 years.

CAREER COUNSELING PROGRAMS

1. Counseling materials may not discriminate based on race, color, national origin, sex, or disability.
2. Counselors must not direct students into programs nor measure their prospects for success based on race, color, national origin, sex, or disability.
3. Counselors may not direct students with disabilities toward more restrictive career objectives.
4. Recipients must ensure that disproportionate enrollments do not result from unlawful discrimination.

SERVICES FOR STUDENTS WITH DISABILITIES

1. No qualified person with a disability may be denied access to, or benefits from any course, program, service, or activity based on disability.
2. Related aids or adaptations must be available as necessary.
3. Recipients must identify, evaluate, and place students with disabilities through a process that includes persons knowledgeable about the student, as well as the student's parent or guardian.
4. Students with disabilities must be placed in the educational setting most appropriate for the student's individual needs.
5. Recipients must place students with disabilities according to the provision of Section 504
6. Tests of academic achievement must measure abilities and achievement rather than disability.

ACCESSIBILITY *(See checklist for web access to UFAS and ADAAG standards; ANSI not available via the web)*

1. Standards for construction initiated on or after 1/27/92 (ADAAG): Each facility or part of a facility, constructed by, on behalf of, or for the use of a recipient, is readily accessible and usable by persons with disabilities.
2. Standards for construction initiated or altered on or after 1/18/91 (UFAS): Each facility or part of a facility constructed by, on behalf of, or for the use of a recipient, is readily accessible and usable by persons with disabilities.
3. Standards for existing facilities construction or alteration initiated before 6/4/1977 (ANSI): Facilities, when viewed in entirety, are readily accessible to disabled persons; programs or activities, when each part is viewed in its entirety, are readily accessible to disabled persons.
4. Standards for construction initiated or altered between 6/4/77 and 1/18/91: Each facility or part of a facility, constructed by, on behalf of, or for the use of a recipient, is readily accessible and usable by persons with disabilities.

COMPARABLE FACILITIES

1. Separate programs or facilities for students with disabilities must be comparable to those of students without disabilities
2. Changing rooms, showers, and other facilities and equipment for students of one sex or students with disabilities must be comparable to those of the other sex and to students without disabilities

WORK STUDY, COOPERATIVE EDUCATION, JOB PLACEMENT, APPRENTICESHIP TRAINING

1. Opportunities in work-study, cooperative education and job placement programs are available to all students, regardless of race, color, national origin, sex, or disability.
2. Recipients must assure that prospective employers do not discriminate based on race, color, national origin, sex, or disability.
3. Recipients may not enter into agreements for apprenticeship training with any entity that discriminates based on race, color, national origin, sex, or disability.
4. Written agreements should include assurances of nondiscrimination.

EMPLOYMENT OF FACULTY AND STAFF

1. Employment practices may not discriminate based on race, color, national origin, sex, or disability.
2. Employment practices may not result in segregation, exclusion, or other discrimination against students.
3. Recipients may not make pre-employment inquiries concerning disability, marital, or parental status.
4. All faculty sources must be notified of nondiscrimination policies.
5. Salary schedules must reflect conditions and responsibilities of employment.
6. All positions must be open to qualified candidates with reasonable accommodations provided.

III. GETTING READY FOR THE VISIT

Who are the system's contact persons for an OCR/MOA Compliance Review?

1. System Superintendent (initial contact for system)
2. CTAE Director or Coordinator
3. School System OCR/MOA Committee Chair (if other than above)
4. Special Ed Director, Maintenance/Facilities Director, Director of Counseling, and Human Resource Director

What should a system do to be ready for the review?

1. Inform the school system staff of the upcoming OCR/MOA Compliance Review visit.
2. Convene an OCR/MOA system team which may include: school superintendent, CTAE director/coordinator, school counselors, special education personnel, bilingual staff, parents, students, school board members, etc.
3. System notifies the GaDOE OCR/MOA Coordinator of who is and how to contact the system contact person.
4. System team will identify documents for use by the on-site review team.
5. Develop an agenda for the on-site review. See the suggested agenda (enclosed).
6. Complete the electronic system facilities accessibility self-assessment instrument. This document should be forwarded to the state OCR/MOA Coordinator at least 30 days prior to the scheduled on-site review.
7. Complete the electronic system self-assessment instrument. This self-assessment document should be forwarded to the state OCR/MOA Coordinator at least 30 days prior to the scheduled on-site review date. This document will require that most exhibits (evidence) requested will be "scanned" as attachments to the self-assessment instrument. There will be minimal requirements for on-site exhibits.
8. Identify individuals from various groups who will complete a question survey concerning the school system. These surveys will be collected, scanned and returned electronically with items 6 and 7 above. (Optional)
9. Identify and schedule use of a room for the OCR/MOA team meeting room. This room will be used all day and there should be tables and electrical service available.
10. Make arrangements to provide lunch for the OCR/MOA team members. An interview room should be provided.
11. Identify and schedule a site for a brief exit report from the OCR/MOA Team chairperson. This report should last no more than 30 minutes.
12. Secure a floor plan of all schools in the selected group in the system. On each of those plans, identify the date that construction began for the building. This date must be shown as the month/day/year (mm/dd/yyyy). If there have been new wings or annexes to the school site, you should show the date when construction began for those sites also. If a lab or area of the school was modified, the start date of construction should be shown for this also. The system facilities director should be able to provide this information. The floor plans should be sent to the GaDOE OCR/MOA Coordinator at least 30 days prior to the on-site visit. A sample floor plan document is enclosed.
13. Send student enrollment data and staff information to the state OCR/MOA Coordinator at least 14 days prior to the on-site visit. (Use the attached spreadsheet for enrollment data)

IV. PREPARING FOR THE VISIT

IDENTIFY STAFF TEAM MEMBERS

It is suggested that school districts convene a team to develop a plan to reach compliance. These teams may include the school superintendent, CTAE supervisor, counselors, special education, and bilingual staff, parents, students, and school board members. This team should focus on compliance with federal requirements as listed below:

DEVELOP OCR/MOA VISIT AGENDA – APPENDIX A

COMPLETE COMPLIANCE REVIEW SELF ASSESSMENT – APPENDIX B

SCHEDULE INTERVIEW TEAMS

COMPLETE FACILITY ACCESSIBLE ASSESSMENT – APPENDIX C

V. **PREPARE DOCUMENTATION NOTEBOOK**

The following items should be compiled in a notebook format with photocopies of the original documents or evidence. If nothing exists, please make that notation on a sheet of paper and insert in the appropriate place. The notebook sections should be labeled with dividers between sections in order as in this outline. These compiled documents will need to be retained by the compliance review team at the end of the site visit. Do not include full notebooks/handbooks/etc. unless requested to do so. A copy of the front page of the notebook/handbook/etc. and the specific section being addressed is usually sufficient. The review team chairperson will coordinate this. ***Please label each document with the Section, number and letter of the requested information. See the following example: (Section 1 – 1.c - Continuous Nondiscrimination Notice BOE Policies System Website)***

▪ **Administrative Compliance**

- a. Copy of the district Public Notice of Nondiscrimination (Annual) as published. (example: newspaper clipping or system and school websites)
- b. Copy of the Continuous Notice of Nondiscrimination as published in several documents. (provide at least 3 different documents)
- c. Identify the Section 504 Compliance Office (name, address, email, phone#)
- d. Identify the Title IX Compliance Officer (name, address, email, phone#)
- e. Provide copies of the district's nondiscrimination Board Policies on Title IX, Section 504, and Equal Employment Opportunity. (BOE policies)
- f. Provide copies of the district's Title IX/Section 504 *Grievance Policy and Complaint Procedures*. (BOE policies and procedures documents)

▪ **Site Location and Student Eligibility**

- a. Provide a copy of the Master Schedule
- b. Provide a campus map of each site offering CTAE instruction. (highlight and identify classrooms/labs)

- c. Identify on the campus map and on the checklist the date of construction (the day of ground breaking or date renovation was started) (not the date the school opened)
- **Recruitment Issues**
 - a. Provide copies of any CTAE area recruiting materials, brochures, flyers, videos, power points and any other materials used in the promotion of CTAE. (provide original copies of these if available)
- **Admissions Issues**
 - a. Provide a copy of the Course Description Booklet if one is available
 - b. Provide a copy of the Student Handbook (can also be used as documentation for continuous nondiscrimination notice, grievance policy and perhaps student eligibility) (put one original copy of handbook in one area then reference to it or photocopy sections from it as needed in other folders)
- **Student Financial Assistance Issues**
 - a. Provide copies of scholarship announcements (all sources – flyers, bulletins, newspaper, morning announcements, etc.)
 - b. Provide a list of local scholarship awards and identification of recipients: male/female, race and national origin (LEP). (Need up to three years of information on this.)
- **Counseling Issues**
 - a. Provide documentation of any language related support services provided LEP students (all that the system provides from any source – don't just list them, provide supporting evidence)
 - b. Provide written overview of the guidance process/procedures to promote educational and career planning and CTAE programs; and include the goals, objectives and activities to address the needs of special populations in the school/district guidance plan
 - c. Provide copies of all career assessments used with students and timeline for their administration
 - d. Provide copies of career-related brochures, newsletters, flyers from the counseling department, etc.
- **Services for Student with Disabilities**
 - a. Provide copies of the process and materials used to identify handicapped/special needs students (if personal records are copied, blacken the name of the student)
 - b. Identify the supplementary aids and services provided to handicapped/special needs students (all that are available for use)
 - c. Identify any physical accessibility concerns campus wide including the parking areas and advise us of those concerns (this is your perceptions)
- **504/ADA Accessibility Issues**
 - a. OCR/MOA Team MUST have the original construction dates for existing facilities and MUST have construction start dates for any addition or renovation to the facility.
 - b. See Checklist # 3 which follows this section.

- **Comparable Facilities Issues** (N/A observation of the facilities by the compliance team)
 - a. Develop OCR/MOA Visit Agenda – Appendix A
 - b. Complete Compliance Review Self-Assessment – Appendix B
 - c. Schedule Interview Team

- **Work Study/Apprenticeship**
 - a. Identify (brief description) the process for admission to all WBL Programs (how does a student get information about this program and go through the admission process)
 - b. Provide copies of any WBL Training Applications
 - c. Provide copies of any Employer Training Agreements
 - d. Provide enrollment data: male/female, LEP, Disable, Black/White/Hispanic (for the entire program)

- **Employment Issues**
 - a. Provide copies of Job Postings for recent Certified and Classified staff position (original copies or photocopies of advertisements and where posted are preferred)
 - b. Provide copies of position recruitment advertisements placed in newspapers, periodicals etc.
 - c. Provide copies of all Employment Application forms (system wide)
 - d. Provide a list of organizations/agencies where Job Announcements appear
 - e. Provide a copy of the District Affirmative Plan (if available)
 - f. Provide copies of District staff recruiting materials (originals or photocopies)
 - g. Provide a description of the process used to screen employment applications (this can be a policy statement or procedures that are endorsed by the system)
 - h. Provide a copy of the Staff Handbook (make a copy of the front page and contents section for our retained records)
 - i. Provide a listing of all sources of staff recruitment (identify teacher training institutions, personnel services, etc.)
 - j. Provide a description of District recruitment efforts (what do you do to advertise and fill a vacancy)

APPENDIX A
(SAMPLE) OCR/MOA COMPLIANCE REVIEW AGENDA

School System _____

System Address _____

Date of Visit _____

OCR/MOA Review Agenda

8:45 – 9:00	OCR/MOA Team Arrival
9:00 – 9:15	Welcome and Introductions System Personnel CTAE Director OCR/MOA Chair
9:15 – 9:25	CTAE Program Overview System CTAE Director
9:25 – 9:40	Instruction & Assignments to Team Members OCR/MOA Review Chair
9:40 – 12:00	Concurrent Activities Facilities Accessibility Documentation Review
	Interviews
	9:40 – 10:00 Students
	10:00 – 10:20 Parents
	10:20 – 11:00 Teachers
	11:00 – 11:20 Counselors
	11:20 – 12:00 Administrators
12:00 – 12:30	Lunch
1:00 – 2:00	Team Compiles Preliminary Reports
2:00 – 2:30	Exit Report (brief informal report)

****Please follow the order of the highlighted interview schedule.***

APPENDIX B
FY2021 GEORGIA OCR/MOA COMPLIANCE REVIEW
SELF-ASSESSMENT

Completed by: _____

Date Completed: _____

System: _____

Instructions: Please complete this document and return to ranukam@doe.k12.ga.us no later than 30 days prior to your scheduled on-site OCR/MOA Compliance Review. This is a WORD document and should be completed and submitted electronically. You will be required to attach “scanned” copies of certain requested information to complete this self-assessment. If you have any questions, please contact Dr. Ray Anukam at 404-657-6589 or at the above email address.

SYSTEM NAME
FY2021 GEORGIA OCR/MOA COMPLIANCE REVIEW
SECTION 1- ADMINISTRATIVE COMPLIANCE

Recipients need to have certain basic requirements in place to comply with the OCR/MOA Guidelines, **(Vocational Education Guidelines)**, Title II, Title VI, Title IX, and Section 504. These basic procedures include an annual public school notice, continuous notification, designation of a person(s) to coordinate activities under Title II, Title XI and Section 504 and a grievance procedure that will allow students, parents and employees at the elementary and secondary level an avenue through which to report and manage alleged discrimination. The district must provide adequate evidence that it takes continuing steps to notify participants, beneficiaries, applicants, elementary and secondary school parents, employees (including those with impaired vision or hearing), and unions or all appropriate professional organizations that it does not discriminate on the basis of race, color, national origin, sex or disability.

1. Continuous Notice of Nondiscrimination (34 C.F.R. §§ 100.6(d), 104.8, 106.9 and 28 C.F.R. § 35.106)

- a) The district has and uses a Nondiscrimination Notice. Yes ___ No ___
- b) All protected groups (race, color, national origin, sex or disability) are included in the nondiscrimination notice. Yes ___ No ___
- c) Attach a scanned copy of the system nondiscrimination statement as shown in the following documents. Make sure the **source and page number** are indicated for each scan.
 - BOE Manual- see attached copy of system BOE Policy web page;
System student services 504 Accommodations web page
 - System Website- see attached copy of System web page
 - School(s) Website(s) - see attached copy of School web page
 - Student Handbook - see attached copy of Student Handbook, page ?
 - Teacher Handbook- see attached copy of Teacher Handbook, page ?
 - Parent Handbook- see attached copy of School Code of Conduct & Student/Parent Handbook, pages?
 - Other system documents- see attached copy of Employee Handbook, page?
Letterhead; Application; School Profile; Course Description Guide,
page?

2. Designation of Compliance Coordinators) Persons Responsible for Coordinating Title IX and Section 504 (4 C.F.R. §§ 104.7(a), 106.8(a), and 28 C.F.R. § 35.107(a))

- a) Name and contact information of each employee of the district designated to

coordinate district efforts to comply with and carry out district responsibilities under:

Title II- _____

Title IX- _____

Section 504- _____

- b) Does the district provide students and employees the name, office address and phone number of the designated coordinators for Title II, Title IX, and Section 504? Yes___ No___.
- c) Attach scanned copies of documents which show how this information is provided to:
- Employees- see attached copy of SCHOOL Teacher Handbook page ? and Employee Handbook, page?
 - Students- see attached copy of SCHOOL Student Handbook, page ?
 - Others- see attached copy of SCHOOL Public Relations Booklet, page ? System web page; and SCHOOL web page.

Make sure the **source and page number** are indicated for each scan.

3. Annual Public Notification (Title IX:34 CFR 106.8(b), Section 504:34 CFR 104.7(a), Title 11:28 CFR.107(a), Guidelines IV-0)

Prior to the beginning of each school year, the district must advise students, parents, employees and the general public that all career and technical education classes and programs are offered regardless of race, color, national origin, sex or disability.

- a) The district published an annual nondiscrimination statement to advise students, parents, employees and the general public that all career and technical education classes and programs are offered regardless of race, color, national origin sex or disability. The notice(s) include a brief summary of program offerings, admission criteria, and the name, office address, and phone number of persons designated to coordinate compliance under Title II, Section 504, and Title IX. Yes___ No___
- b) Attach scanned copies of the following:
- Local newspaper publication of nondiscrimination statement- see attached the name of the local org, date of newspaper article
 - System website notifications - see attached copy of system web page
 - School website notifications- see attached copy of SCHOOL web page

Make sure the **source and page number** are indicated for each scan.

4. **Grievance Procedure (Section 504:34 CFR 104.7(b), Title IX:34 CFR 106__8(b), Title II: 28 CFR 35.107(b))**

- a) Does the district have a board-approved grievance procedure that provides for prompt and equitable resolution of student and employee complaints alleging any discrimination based on sex or disability? Yes___No___
- b) What is the BOE policy number concerning your district's grievance procedures.

Attach a scanned copy of the system grievance procedures as shown in the following documents.

- BOE Policy Manual - see attached School web pages; and BOE Policies, List of Policies
- Student Handbook - see attached copy of SCHOOL Student Handbook, page?
- Teacher/Staff Handbook- see attached copy of SCHOOL Teacher Handbook, page? Employee Handbook, page?
- System and/or School Websites - see attached copies of system and SCHOOL web pages
- Bulletin Board Announcements- see attached copy of SCHOOL Bulletin Board
- Others- SCHOOL Course Description Guide, page?

Make sure the **source and page number** are indicated for each.

***SCHOOL = change to initials of school.**

SYSTEM NAME

FY2021 GEORGIA OCR/MOA COMPLIANCE REVIEW

SECTION 2 -SITE LOCATION AND STUDENT ELIGIBILITY

Standards established for site selection, and criteria for student eligibility cannot have the purpose or effect of discriminating, segregating, or excluding students on the basis of race, color, national origin, sex or disability. Issues that could result in discrimination or segregation include: the selection of sites for career and technical education facilities, geographic residence requirements, numerical limits for students from schools of origin, addition to existing career and technical education facilities, and any other criteria that have the purpose or effect of disproportionately excluding students of a particular race, national origin, sex or disability.

1. Student Eligibility (Guidelines IV-A)

- a) Identify the BOE policy number for the district's student admission eligibility criteria.
- b) Attach a scanned copy of the system's student admission eligibility criteria as shown in the following documents.
 - BOE Policy Manual- see attached copy of BOE Policy Numbers
 - Student Handbook- see attached copy of page? from student handbook
 - Teachers/Staff Handbook- see attached copy of page? from teacher handbook
 - System and/or School Websites- see attached system and SCHOOL web page

Make sure the **source and page number** are indicated for each.

2. Site Selection and Modifications (Guidelines IV-B, Guidelines IV-D)

District policies procedures and outcomes ensure that additions, modifications, or renovations to the physical plan of any school facility do not create, maintain, or increase segregation on the basis of race, color, national origin, sex or disability.

- a) Does the district have policies and procedures to ensure that additions, modifications, or renovations to the physical plan of any school facility do not create, maintain, or increase segregation on the basis of race, color, national origin, sex or disability?

Yes___ No___

b) Attach a scanned copy of the system's BOE policy that addresses the policies and procedures that ensure that additions, modifications, or renovations to the physical plan of any school facility do not create, maintain, or increase segregation on the basis of race, color, national origin, sex or disability. - see attached copy of BOE Policy Number

c) Are the district's career and technical education facilities at sites that are readily accessible to both minority and non-minority communities and that do not tend to identify the facility or program as designed for minority or non-minority students?
Yes___ No_____

d) Attach scanned copies of the following:

- School floor plan with CTAE classes clearly marked- see attached floor plans of SCHOOL
- School floor plan with the date of construction starts (the date of groundbreaking or date of renovation started) for all areas where modifications have been made to the school-working
- Copy of each secondary school Master Schedule

3. Residency (Guidelines IV-C)

a) Attach a scanned copy of the system's established geographic service area boundaries that are established for each secondary school.

The SYSTEM NAME SchoolDistrict is comprised of? secondary high school serving students in grades 9-12. The geographic service area of the high school encompasses all of SYSTEM NAME.

SYSTEM NAME
FY2021 GEORGIA OCR/MOA COMPLIANCE REVIEW
SECTION 3- RECRUITMENT ISSUES

Recruitment activities and materials should convey the message that all career and technical education programs are open to all students without regard to race, color, national origin, and sex or disability status. Information about career technical education opportunities should be available to all potential students. Promotional materials should avoid stereotyping. Recruitment teams, to the extent possible, should represent persons of different races, national origins, gender, and disabilities.

1. Recruitment Activities (Title IX: 34 CFR 106.23 (a) (b) Guidelines V-C)

a) Does the district conduct recruitment activities so as not to exclude or limit opportunities on the basis of race, color, national origin, sex or disability?

Yes___ No___

b) Attach scanned copies of:

- Documents (agendas, letters, announcements, etc.) that demonstrate recently conducted recruitment activities for CTAE programs.
- CTAE Brochures
- CTAE Flyers
- Other CTAE promotional materials.

2. Recruitment Materials (Guidelines V-C)

a) Do the district's policy, procedures and /or practices for selecting and using recruitment materials ensure that career and occupational opportunities are not limited on the basis of race, color, national origin, sex or disability?

Yes___ No ___

b) Attach a scanned copy of the policies, procedures and /or practices used for selecting and using recruitment materials to ensure this. **See attached practices description**

c) Are the district student, teacher or counselor teams who are involved in the recruitment process and provide information about opportunities and courses representative of the diversity of the student and community populations?

Yes___ No___

3. Counselor Communication (Guidelines V-D) (34 C.F.R. §§ 100.3(a) and (b) and 104.37(b))

- a) Identify the district policies, procedures and outcomes which ensure that counselors can effectively communicate with students who are limited English proficient and also with students who are sensory impaired.
- b) Attach scanned copies of the policies and procedures utilized by counselors to ensure that they can communicate with students who are limited English proficient **and students who have hearing impairments.**
 - Translation services
 - Bilingual staff members
 - Special Education services
 - System support agencies

4. Promotional Efforts (Guidelines V-E)

- a) Attach scanned documents which support that the district provides promotional materials and efforts that do not create or perpetuate stereotypes or limitations based on race, color, national origin, sex or disability. - **See attached School Equity Plan, page ?; other efforts**
- b) Attach scanned documents that identify system/school procedures and staff responsible for regularly evaluating whether promotional materials and efforts create or perpetuate stereotypes or limitations based on race, color, national origin, sex or disability.

See attached practices description

5. Community of Persons of Limited English Proficiency (Guidelines V-E)

- a) Does the district serve a community (must be 5% or more of your population) of persons with limited English proficiency at this time?
Yes__ No __
- b) If Yes, identify the race.
- c) Attach scanned documents which show that information has been provided to LEP parents, students and community members in their own language or through other alternative means to ensure that all students have equal access to and support to be successful in school.
 - Copies of general announcement letters
 - Parent Handbooks in native languages

- System forms in native languages
- Copies of the system protocol for providing information to LEP students, parents, and community members

Make sure the **source and page number** are indicated for each.

SYSTEM NAME
FY2021 GEORGIA OCR/MOA COMPLIANCE REVIEW
SECTION 4- ADMISSIONS ISSUES

Admission policies, procedures and criteria may not exclude students from career and technical education programs on the basis of race, color, national origin, sex or disability. Where admissions criteria exclude a disproportionate number of persons of a particular race, color, national origin or sex or persons with disabilities, the criteria should be validated as essential to success in the program. Preadmission inquiries about marital, parental or disability status should be avoided.

1. Admission Criteria-Race, Color, National Origin, Sex or Disability {Guidelines IV-K}

- a) Attach scanned copies of at least 3 district /school sources where the program or course admissions criteria are noted/published. - See attached School Course Description Guide, page?; list brochures; and School FY15 Master Schedule
Make sure the **source and page number** are indicated for each.

2. Admission Criteria – Marital, Parental, or Disability Status {Title IX:34 CFR

106.21(c), Section 504:34 CFR 104.42 (b) (4), Title II 28 CFR 35) (34 C.F.R. § 104.4(a) and (b)

- a) Does the district include information about marital, parental, or disability status in its course and/or program eligibility and admission criteria? Yes___ No ____.
- b) If so, attach a scanned copy of any documents that include this restricted information.

3. Admission Criteria - Employment Opportunities Based on Disability (Section

504:34 CFR 104.10, Section 504: 34 CFR 104.43(c), Guidelines IV-N) (Guidelines IV-N) (34 C.F.R. §§ 104.4(a) and (b))

- a) Does the district provide access to career and technical education, and academic programs or courses to students with a disability despite general perceptions that employment opportunities in an occupation may be more limited for disabled persons than for non-disabled persons? Yes___ No ____
- b) Attach a scanned copy of the enrollment data for each CTAE class. Be sure that the number of students with IEPs is indicated by classes. **FY2021 Enrollment data**

4. Admission Criteria-Limited Language Skills (Guidelines IV-L)

- a) Does the district serve a community (5% or more of your population) of persons with limited English proficiency at this time? Yes__ No __ What percent of your population is limited English proficient? _____
- b) If your answer is Yes, what is the language(s)? _____
- c) Does your system, at both the elementary and secondary level, use a standardized method of identifying students with limited English language proficiency?
Yes__ No__
- d) If your answer is yes. What system is used? _____
Attach a scanned copy of the instrument used for determining limited English language proficiency.
- e) Are district students with limited English language proficiency more restricted from admission and participation in career and technical education programs and courses than are students whose primary language is English? Yes __ No
- f) Does the district use a standardized method to assess the ability of students with limited English proficiency to participate in career and technical education?
Yes__ No __
- g) What method is used? __If same as discussed above, please so note.
 - a. Does the district provide accommodations necessary for students with **limited** English proficiency to participate in and benefit from all career and technical programs? Yes__ No__

SYSTEM NAME
FY2021 GEORGIA OCR/MOA COMPLIANCE REVIEW
SECTION 5- STUDENT FINANCIAL ASSISTANCE ISSUES

Recipients are not to limit honors, awards, and scholarships to a group on the basis of race, color, national origin, sex or disability unless such targeting is done to provide opportunities to members of a group that has not traditionally been represented. Outside agencies that provide awards are to be notified of the district's nondiscrimination policy.

A recipient may administer or assist in the administration of scholarships, fellowships, or other forms of financial assistance established pursuant to domestic or foreign will trust, bequests or similar legal instruments or by acts of a foreign government which require that awards go to a student of a particular sex, race, or national origin, or with a student with a particular disability.

However, the overall effect of such restricted awards and scholarships must not lead to discrimination in access to total scholarships on the basis of sex, race, national origin or disability. To meet this requirement, a district must implement a review process and keep records for no less than 5 years.

1. Availability to All Students (Title VI: 34CFR 100.3(b), Title IX: CFR 106.37, Section 504:34 CFR 104.46(a), Guidelines VI-B)

- a) Does the district employ a process for providing information about and awarding financial assistance that ensures it is available to all students regardless of sex, race, color, national origin, or disability? Yes ___ No ___

- b) If your answer is Yes, attach scanned copies of the local systems procedures or instruments used – see attached [Procedures for Financial Assistance](#)

2. Sex-restricted Awards (Title IX:34 CFR 106.37, Guidelines VI-B)

- a) Does the district offer any sex-restricted awards? Yes ___ No ___
- b) If your answer is Yes, what awards and why:
- c) If your answer is Yes, does the district ensure that any sex-restricted awards are made only when established by will, trust, bequest, or other legal instrument?
Yes ___ No ___
- d) Does the district regularly review their awards process to ensure that the overall effect of the awards does not discriminate on the basis of sex? Yes ___ No ___
- e) If yes, attach a scanned copy of the procedures used.

3. Assistance for National Origin Minority Persons (Guidelines VI-B) - Our LEP population is _____%

a) Does the district serve a community (5% or more of your population) of persons with limited English proficiency at this time? Yes ___ No ___

b) If your answer is Yes, what other languages? _____

c) Does the district provide information about financial assistance to national origin minority persons in their native language? Yes ___ No ___.

If yes, provide a scanned copy of the notification documents that are used.

SYSTEM NAME
FY2021 GEORGIA OCR/MOA COMPLIANCE REVIEW
SECTION 6- COUNSELING ISSUES

Issues relating to counseling and prevocational programs may include steering of students toward particular courses or programs that are “traditional” for the student’s race, color, national origin, English language proficiency, sex, or disability status. Services and materials related to counseling and recruitment must be free of discrimination and stereotyping in language, content and illustration.

1. Counseling Materials and Activities – Overall (Title IX: 34 CFR 106.21 (a)(b), Title IX:34 CFR 106.36 (a), Title IX: 34 CFR 106.34, Section 504: 34 CFR 104.4 (a) and 104.34 (a) and (c), Section 504: 34 CFR 104.47 (b), (34 C.F.R. § 104.37(b)), Title II: 28 CFR 35.130, Guidelines V-A

- a) Does the district regularly review their counseling materials and activities (including student course and/or program selection and career/employment selection), promotional and recruitment efforts to ensure that they do not discriminate on the basis of race, color, national origin, sex, or disability? Yes_____ No_____.
- b) If your answer is yes, attach a scanned copy of any protocols or procedures used. [See attached Procedures for Review of Counseling Materials & Activities \(narrative\)](#)

2. Course and Program Selection Process – All Students (Title IX: 34 CFR 106.34, Section 504:34 CFR 104.47 (b), Guidelines V-B)

- a) Do the district’s guidance counselors employ a course and/or program selection process that ensures choices are not made based on the student’s race, color, national origin, sex or disability? Yes__ No__
- b) If your answer is no, how do you ensure that choices are made without regard to the student’ race, color, national origin, sex or disability?

- c) Do the district’s guidance counselors routinely evaluate the districts process and their own practices to maintain an unbiased approach? Yes__ No__
- d) If your answer is yes, how is this done?

Include a scanned copy of any minutes of meetings regarding this. [See attached “HS Scheduling course description; Faculty Scheduling and procedures for 1.b.](#)

3. Counseling Materials and Activities – Students with Disabilities (Section 504:34 CFR 104.37 (b), Guidelines V-B)

- a) Does the district regularly review its counseling materials and activities (including student course and/or program selection and career/employment selection), promotional, and

recruitment efforts to ensure that they do not discriminate on the basis of disability? Yes ___
No ___

Attach a scanned copy of any minutes of meetings regarding this. [See procedures and documentation for 1.b. and 2.b.](#)

4. Disproportionate Enrollments (Title IX: 34 CFR 106.36 Guidelines V-B)

If disproportionate enrollments occur, efforts must be made to ensure that counseling activities, services and/or materials are not responsible. Recipients must take steps to ensure that any disproportionate enrollment does not result from unlawful discrimination in counseling activities.

- a) Does the district annually identify courses with disproportionate enrollments, take steps to identify the reason for the disproportion, and implement strategies to balance the enrollment in future years? Yes ___ No ___
- b) If your answer is yes, explain your process: See procedures and documentation for 1.b. and 2.b.; attached Equity Plan, page?
- c) Do the guidance counselors routinely evaluate their own practices to ensure that they do not contribute to any disproportion in enrollment patterns? Yes ___ No ___
- d) If your answer is yes, explain what is done. _____

Attach copies of any professional development meetings (local or otherwise) that counselors have attended regarding this matter. [See procedures and documentation for 1.b. and 2.b.](#)

SYSTEM NAME
FY2021 GEORGIA COMPLIANCE REVIEW
SECTION 7 – SERVICES FOR STUDENTS WITH DISABILITIES

No qualified person with a disability may be excluded from, denied benefits of, or subjected to discrimination in any course, program or activity. A recipient may not restrict access for students with disabilities to schools, programs, services, and activities because of architectural barriers, equipment barriers, the need for related aids and services, or the need for auxiliary aids. Section 504 and ADA Title II are based on the premise that students with disabilities will be integrated with their non-disabled peers as much as possible.

1. Non Discrimination for Students with Disabilities (Section 504: 34 CFR 104.4 (a), 34 C.F.R. §§ 104.33-36, Title II: 28 CFR 35 ___ 130 (a), Guidelines IV-N)

a) Explain how the district ensures that no qualified person with a disability is excluded from, denied benefits of, or subjected to discrimination in any course, program, service, or activity solely on the basis of disability. Reference any appropriate policies, procedures and outcomes. - see attached explanation Child Find documents.

b) Have any students with disabilities been excluded from academic or career and technical education programs, courses, services, or activities due to equipment barriers or because necessary related aids were not available? Yes ___ No ___

c) If your answer to b is yes, explain:

2. Provision of Elementary and Secondary 504 Services (Section 504: 34 CFR 104.33, 35, and 36)

a) Do the district policies, procedures and outcomes ensure that a *free*, appropriate public education (FAPE) is available to each qualified disabled person in its jurisdiction?

Yes ___ No ___

b) Explain your answer to a) above: see attached explanation "Procedures for Ensuring FAPE, Child Find, Impartial Review"; see documents "Ensuring FAPE- OCR/MOA Dear Colleague Letter"; and "System 504 Web Page".

c) Explain the district's system that is in place for the identification of disabled persons, the evaluation of disabled persons, and the educational placement of disabled persons. - see attached explanation "Procedures for Ensuring FAPE, Child Find, Impartial Review"; see document "System 504 Web Page".

- d) Are placement decisions made by a group of persons knowledgeable about the child, the meaning of evaluation and data, and placement options? Yes ___ No ___

Attach a scanned copy of an IEP meeting held for a CTAE student in your system. Be sure to remove any personally identifying information. - see attached IEP documentation.

- e) Explain the district's procedural safeguards through which parents or guardians can obtain an impartial review of the evaluation and placement actions. - see attached explanation "Procedures for Ensuring FAPE, Child Find, Impartial Review"; see documents "System 504 Web Page"; and "Due Process Checklist for HS CTAE Student".

3. Supplementary Aids, Services and Support (Section 504: 34 CFR 104.34 (a) (b), Title II: 28 CFR 35.139 (d) Guidelines VI-A)

- a) Identify and explain the district's policies, procedures and outcomes to ensure that disabled secondary students are placed, with the use of supplementary aids and services, in the regular educational environment of any career and technical education, academic, physical education, athletic, or other school program or activity. - see attached explanation "Ensuring LRE with Supplementary Aids & Services".

4. Free and Appropriate Education (FAPE) - Career and Technical Education (Section 504: 34 CFR 104.35 (a), Guidelines VI-A)

- a) Identify and explain the district's policies, procedures and outcomes to ensure that secondary students with disabilities are placed in a career and technical education program only when the 504 FAPE requirements for evaluation, placement, and procedural safeguards have been satisfied. - see attached documentation: "Ensuring FAPE-OCR/MOA Dear Colleague Letter"; "System 504 Web Page"; "Due Process Checklist for HS CTAE Student"; "Ensuring LRE with Supplementary Aids & Services"; CTI Program Information"; "GADOE Special Education Rules Implementation Manual -Part I & Part II"; "Transition Planning; and "504 Training Documents".

SYSTEM NAME
FY2021 GEORGIA OCR/MOA COMPLIANCE REVIEW
SECTION 8 – 504-ADA ACCESSIBILITY

The recipient may not exclude students with disabilities from enjoying the benefits of its program or service because its facilities are inaccessible to or unusable by persons with disabilities. Applicable accessibility standards are determined by the date the facility was constructed or last renovated by the institution.

- 1. Existing Facilities/Section 504 (34 CFR, 104.22)- construction or alteration initiated before 6/4/77 – 11 readily accessible"-** A recipient shall operate its program or activity so that when each part is viewed in its entirety, it is readily accessible to disabled persons. A recipient is not required to make each of its existing facilities or every part of a facility accessible to and usable by persons with disabilities.

- 2. New Construction/Section 504 (34 CFR 104.23)- construction or alteration initiated between 6/4/77 and 1/1791- ANSIA117.1-1961 (R1971) –** Each facility or part of a facility constructed by, on behalf of, or for the use of a recipient is designed and constructed in such a manner that the facility or part of the facility is readily accessible to and useable by persons with disabilities. Conformance with the "American National Standard Specifications for Making Buildings and Facilities Accessible to, and Usable by the Physically Disabled," published by the American National Standards Institute, Inc. (ANSIA117.1-1961 (R1971) Later versions of ANSI A117.1 do not apply. (prior to January 18, 1991 amendment)

- 3. New Construction/Section 504 {34 CFR 104.23 and Title II-28 CFR 35.151) –** construction or alteration initiated on or after 1/18/91- UFAS- Each facility or part of a facility constructed by, on behalf of, or for the use of a recipient or public entity is designed and constructed in such a manner that the facility or part of the facility is readily accessible to and usable by persons with disabilities. Conformance with the Uniform Federal Accessibility Standards (UFAS) (Appendix A to 41CFR subparts 10119.6). Departures from particular technical and scoping requirements permitted where substantially equivalent or greater access to and usability of the building is provided.

- 4. New Construction/ADA (28 CFR 35.151) –** Construction or alteration initiated on or after 1/27/92- Each facility or part of a facility constructed by, on behalf of, or for the use of a recipient or public entity is designed and constructed in such a manner that the facility or part of the facility is readily accessible to and useable by persons with disabilities. Conformance with either ADAAG or UFAS is acceptable.

1. Provide a scanned composite floor plan of each secondary school in the district.
2. On each floor plan, mark the "start date of construction" for the original school. Note that this date is not the date the school opened, but the date when construction began.
3. On the same floor plan, circle any areas and write in the start date of construction for any area(s) that has been modified since the original school was built. This includes where modifications were made to doors, restrooms, water fountains, walkways/ramps, labs, etc.
4. On the same floor plan, circle any areas and write in the start date of construction for any area(s) that has been added since the original school was built.
5. On the same floor plan, highlight and identify by name all CTAE labs.

SYSTEM NAME

FY2021 GEORGIA OCR/MOA COMPLIANCE REVIEW

SECTION 9 – COMPARABLE FACILITIES ISSUES

Separate facilities for students with disabilities should be similar in quality and convenience to facilities for students without disabilities. Separate changing rooms, showers and other facilities for students on one sex should be similar in quality and convenience to facilities for students of the other sex. Any separate facilities for male, female or disabled students should be located in similar proximity to the associated classrooms, shops or laboratories. LEP/ELL program facilities should be comparable to those for non-LEP students.

1. Separate Programs or Facilities (Section 504:34 CFR 104.34 (c), Guidelines VI-A)

- a) Do separate programs or facilities exist for students with disabilities? Yes___ No___
- b) If your answer is yes, identify these:
- c) Are these separate programs or facilities comparable to those for students without disabilities? Yes___ No___
- d) Do separate programs or facilities exist for LEP students? Yes___ No___
- e) If your answer is yes, identify these:
- f) Are these separate programs or facilities comparable to those who are fully English proficient? Yes___ No___
- g) If separate programs exist for students of one sex, they must meet the requirements of Title IX of the Education Amendments of 1972. Do separate programs exist for students of one sex? Yes___ No___
- h) If your answer was yes, identify these:

2. Changing Rooms, Showers and Other Facilities (Title IX:34 CFR 106.33, Section 504:34 CFR 104.4 {b} {ii), Guidelines VI-D)

- a) Are the changing rooms, showers, and other facilities for students of one sex comparable to those provided to students of the other sex?
- b) Are changing rooms, showers, and other facilities for students with disabilities comparable to those provided to students without disabilities? Yes___ No___

SYSTEM NAME

FY2021 GEORGIA OCR/MOA COMPLIANCE REVIEW

SECTION 10 – WORK STUDY, COOPERATIVE EDUCATION, JOB PLACEMENT, AND APPRENTICE TRAINING ISSUES

An agency not only has the responsibility to provide its services in a nondiscriminatory manner, but it also has the responsibility not to contribute to or support discriminatory practices by non-school organizations that provide employment or workplace learning sites. Assignments cannot be made or withheld in work-based learning programs simply because of sex, race, national origin or disability of the student. It is also illegal to cooperate with an employer who requests that school refer or identify students on the basis of sex, race, color, national origin or disability status. It is recommended that agencies have written agreements whereby the cooperating worksite staff indicates that they will not discriminate and that they understand the school or consortium cannot work with any provider that does. It is necessary to regularly review these written agreements, the assignments of students presently in such programs, and the placement process to see whether any segregated or restrictive patterns exist.

1. Work-Based Learning Opportunities {Title VI:34 CFR 100.3 (b), Title IX: 34 CFR 106.31(d), Section 504:34 CFR 104.4 (b), Guidelines VII-A}

- a) Does the district independently operate a work-based learning program?
- b) If your answer is yes, do the criteria used for selecting and placing students in work-study, cooperative education, and work-based learning programs ensure that opportunities are available to all students regardless of race, color, national origin, sex, or disability?
Yes _____ No _____
- c) If your answer is No, explain:
Attach a scanned copy of the system's Work-Based Learning Handbook. See attached document "GADOE Web Site for CRE/WBL Manual".

2. Partnering Employers and Prospective Employers (Title VI: 34 CFR 100.3 (b), 34 C.F.R. § 100.3(c), 34 C.F.R. § 104.11, Title IX: 34 CFR 106.38, Section 504:34 CFR 104.46(b) 34 C.F.R. § 104.37(a) (b), Guidelines VII-A),

- a) Are there processes and practices established by the district to ensure that partnering employers and prospective employers do not discriminate on the basis of race, color, national origin, sex, or disability in recruitment, hiring/firing, placement, assignment of work tasks, hours of employment, levels of responsibility, and pay? Yes _____ No _____
- b) Who developed these processes and practices? School WBL Coordinator using GADOE CRE/WBL manual guidance.

- c) Does the district monitor and keep records of the employment practices of partnering employers and prospective employers to ensure that they do not discriminate against students on the basis of race, color, national origin, sex, or disability in recruitment, hiring/firing, placement, assignment of work tasks, hours of employment, levels of responsibility and pay? Yes__ No__
- d) Are written agreements used to ensure that employers and prospective employers do not discriminate against students on the basis of race, color, national origin, sex, or disability in recruitment, hiring/firing, placement, assignment of work tasks, hours of employment, levels of responsibility, and pay? Yes__ No

Attach a scanned copy of an active WBL student application which shows signatures of the student, parent, school coordinator and employer. Remove student identification numbers such as social security numbers if they are include.

- e) If your answer is yes, do the written agreements used contain a nondiscrimination statement which is adequate in the assurance of nondiscrimination?

Yes__No__

SYSTEM NAME
FY2021 GEORGIA OCR/MOA COMPLIANCE REVIEW
SECTION 11 – EMPLOYMENT ISSUES

Recipients are prohibited from engaging in any employment practice that discriminates against any employee or applicant for employment on the basis of sex, disability, race, color or national origin. This requirement covers hiring and firing, recruitment and selection matters, compensation, promotion, reasonable accommodation, and affirmative action to overcome the effects of past discrimination.

1. Notification to Faculty and Staff (Guidelines VIII-B)

- a) Does the district have policies, procedures and outcomes to ensure nondiscrimination in employment for current and potential employees? Yes__ No__
- b) If your answer is yes, identify where these policies, procedures and outcomes are located: see attached website documentation for policies
- c) Do the district policies, procedures and outcomes apply to each of the protected group categories? Yes__ No__
- d) Do all negotiated agreements with staff contain a nondiscrimination statement?
Yes__ No__

Attach a scanned blank copy of an employment agreement.- See attached Classified Employment Application and Certified Contract

Identify how the district takes continuing steps to notify every source of faculty or staff that it does not discriminate on the basis of race, color, national origin, sex or disability? Attach scanned copies of at least three documents that show this. See attached copy of School web pages; copies of Employee Handbook, page ?; and School Bulletin Board Postings

2. Salary, Scales and Other Benefits of Employment (Title IX:34 CFR 106.54, Section 504: 34 CFR 104.11 and 12, Guidelines VIII-D)

- a) Are the negotiated agreements for faculty and staff that pertain to salary and other benefits of employment established without regard to race, color, national origin, sex or disability?
Yes__ No__

3. Equal Employment Opportunities for Disabled Persons (Section 504:34 CFR 104.12, Guidelines VIII-E)

- a) Do the district's policies and procedures specifically address the way in which it provides equal employment opportunities for disabled persons?

- b) Reference the specific policies and procedures (and their locations) that address the way in which the district provides equal employment opportunities for disabled persons. **(Policies)**see attached copy of School web page
- c) Does the district provide equal employment opportunities to disabled persons and employees by making reasonable accommodations for physical or mental limitations?
- d) If your answer is no, explain why.

APPENDIX C FACILITIES ACCESSIBILITY SELF-ASSESSMENT

A review of each secondary school where CTAE classes are offered will be made. The accessibility review will include libraries, cafeterias, resource rooms, counseling and administrative offices, lavatories, parking areas, building entrances, hallways, as well as CTAE program areas and other areas as determined. The review will typically NOT include academic classrooms.

CHECKLIST FOR COMMON ACCESSIBILITY GUIDELINES:

All agencies are responsible for compliance with Section 504. Applicable accessibility standards are determined by the date the facility was constructed or last renovated, as follows (ANSI, UFAS, and ADAAG standards):

- Existing facilities/Section 504 (34 CFR, 104.22) – construction or alteration initiated before 6/4/77
- New construction/Section 504 (34 CFR 104.23) – construction or alteration initiated between 6/4/77 and 1/17/91. Facilities follow American National Standards Institute, Inc. (ANSI) A117.1-1961 (R1971)
- New construction/Section 504 (34 CFR 104.23) – construction or alteration initiated on or after 1/18/91. Facilities follow the Uniform Federal Accessibility Standards (UFAS) Appendix A to 41 CFR subparts 101-19.6 (UFAS can be found <http://www.access-board.gov/ufas/ufas-html/ufas.htm>) and <http://www.access-board.gov/ufas/ufas-html/figures.htm>)
- New construction/Americans with Disabilities Act Title II (28 CFR 35.151) – construction or alteration initiated on or after 1/27/92 – Facilities follow Americans with Disabilities Act Accessibility Guidelines for Buildings and Facilities (ADAAG can be found at Appendix A to 34 CFR Part 36, or may elect to follow UFAS Appendix A to 41 CFR subpart 101-19.6 at (<http://www.access-board.gov/adaag/html/adaag.htm> and <http://www.access-by-design.com/adaag/group12.htm>)

The below checklist provides a framework for appraisal of common problems or violations that may exist in your local schools regarding access and modifications as described by the Americans with Disabilities Act, and guidelines published by the U.S. Education Department Office for Civil Rights (for facilities constructed after 1/27/92). These are the areas to be reviewed in each secondary school.

You should complete the following self assessment for each secondary school which is a part of this compliance review. Indicate yes or no as appropriate.

Name of System: _____

Name of School: _____

Date Completed: _____

Completed by: _____

Building Access

Yes No N/A Handicapped parking spaces(s) are designated and located near building/events for disabled individuals.

Total Number of Parking Spaces Provided in Parking Facility	Minimum Number of Required accessible Parking Spaces
1 to 25	1
26 to 50	2
51 to 75	3
76 to 100	4
101 to 150	5
151 to 200	6
201 to 300	7
301 to 400	8
401 to 500	9
501 to 1000	2 percent of total
1001 and over	20, plus 1 for each 100, or fraction thereof, over 1000

Yes No N/A Parking space allocation for individuals with disabilities meets ADA guidelines (96" wide with a 60"/96" access aisle).

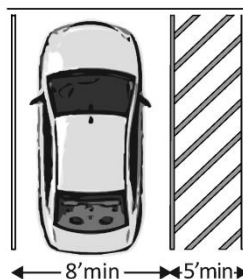

Yes No N/A Of the accessible spaces, is at least one a van accessible space (11' with 5' aisle, or 8' with 8' aisle)?

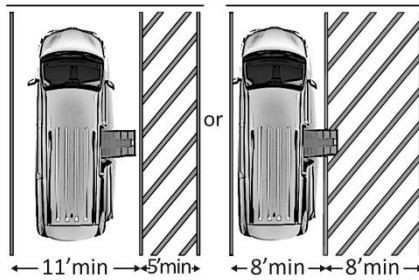

Yes No N/A

Are accessible spaces identified with a sign at least 60" above ground (Van space identified)?

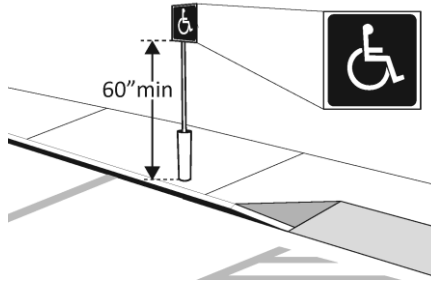

Yes No N/A
 Yes No N/A

Reserved spaces are at least 12 feet long by 6 feet wide.
 There is a ramp, if necessary, between reserved parking space and the building.



Yes No N/A
 Yes No N/A
 Yes No N/A
 Yes No N/A
 Yes No N/A
 Yes No N/A

There is a "drop off" zone near the building entrance.
 The gradient/slope from parking to building does not exceed 1:12.
 Entrance door handle has a lever handle that is easy to grasp.
 The entrance door has clear opening at least 32".
 The door opens easily with less than five (5) pounds of pressure.
 Accessible facilities are identified.

Curb, Ramps, and Walks

Yes No N/A
 Yes No N/A

All the ramps have an edge no greater than 1/2 inch.
 All ramps have no more than 1:12 maximum slope.

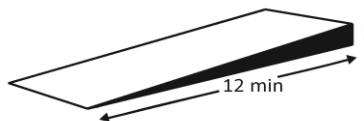

Yes No N/A

Ramps are at least 36 inches wide.

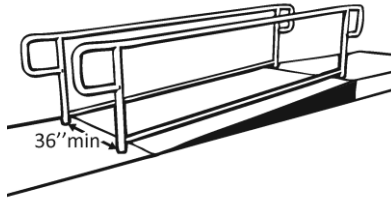

- Yes No N/A
- Yes No N/A
- Yes No N/A
- Yes No N/A
- Yes No N/A
- Yes No N/A
- Yes No N/A

Handrails are placed on each side of the ramp if it rises more than 6".
 Height of handrails above ramp is 34" – 38".
 Walkways and travel paths are at least 36 inches wide.
 Walkways are clear of debris and/or hazardous objects.
 Outside steps and travel paths are protected from inclement weather.
 The floor surface of the travel path is hard and not slippery.
 Ramps have a slope of 1 to 20 (1 to 12 with handrails).
 Is there a level landing where the ramp changes direction that is at least 60 x 60 inches?

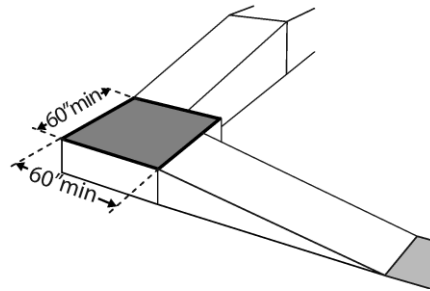

- Yes No N/A

If the threshold is vertical, is it no more than 1/4 inch high? If 1/2 to 3/4 inch high, the bevel should be no greater than 1:2.

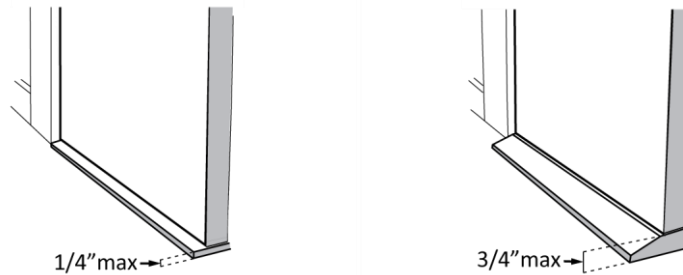

- Yes No N/A

Is the running slope of the curb ramp no steeper than 1:12?

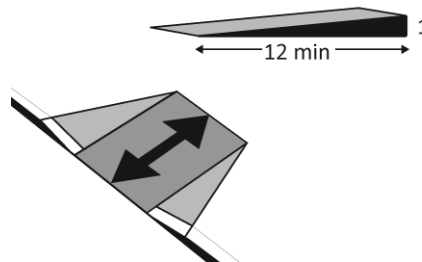

__ Yes __ No __ N/A

At the top of the curb ramp is there a level landing (slope no steeper than 1:48 in all directions) that is at least 36 inches long and at least as wide as the curb ramp?

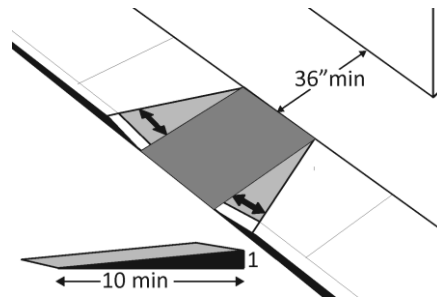

Common Areas (Office, Cafeteria, Library, etc.)

__ Yes __ No __ N/A

Obstacles (telephone, fountains, etc.) protrude less than 4" into the corridor. *Does not apply to construction before January 18, 1991.*

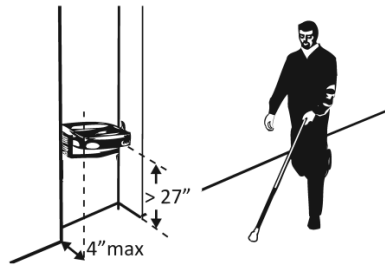

__ Yes __ No __ N/A

Height of drinking fountain spout 36" max above floor.

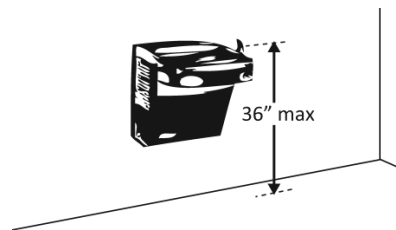

__ Yes __ No __ N/A

Can the drinking fountain control be operated with one hand and without tight grasping, pinching or twisting of the wrist?



__ Yes __ No __ N/A

Main office service counter has an area lowered for ADA accessibility (36" max).

__ Yes __ No __ N/A

Food service counters (lunchroom counters, student store counters, etc.) have areas lowered for ADA accessibility (no less than 28" or greater than 34").

__ Yes __ No __ N/A

Clear width of foodservice line is 36" min.

Yes No N/A Are there signs designating permanent rooms and spaces not likely to change over time?
 Are the signs 48" – 60" above the floor?
 Yes No N/A Library service counters have an area lowered for ADA accessibility.

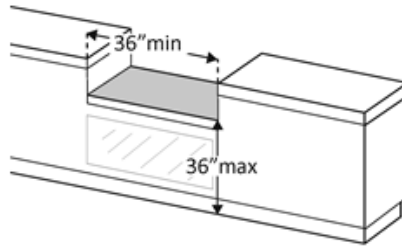

Yes No N/A There are exit signs and horn strobes for emergency and fire safety.
 Yes No N/A Stair treads are at least 11" (uniform) and the height of the stair riser is 4" – 7" (uniform).

Gyms, Stadiums, and Auditoriums

Yes No N/A All play fields are ADA accessible.
 Yes No N/A All routes of travel to building and play and sports fields are ADA accessible.
 Yes No N/A Gymnasium/auditorium/stadium seating area is ADA accessible.

# of Seats	Wheelchair Spaces
4 - 25	1
26 - 50	2
51 - 150	4
151 - 300	5

Yes No N/A In dressing rooms, is a bench provided with back support?

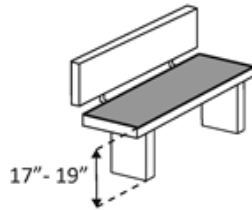

Yes No N/A Transfer type shower compartments shall be 36 inches by 36 inches clear inside dimensions measured at center points of opposing sides and shall have a 36 inches wide minimum entry on the face of the shower compartment. Clearance of 36 inches wide minimum by 48 inches long minimum measured from the control wall shall be provided.

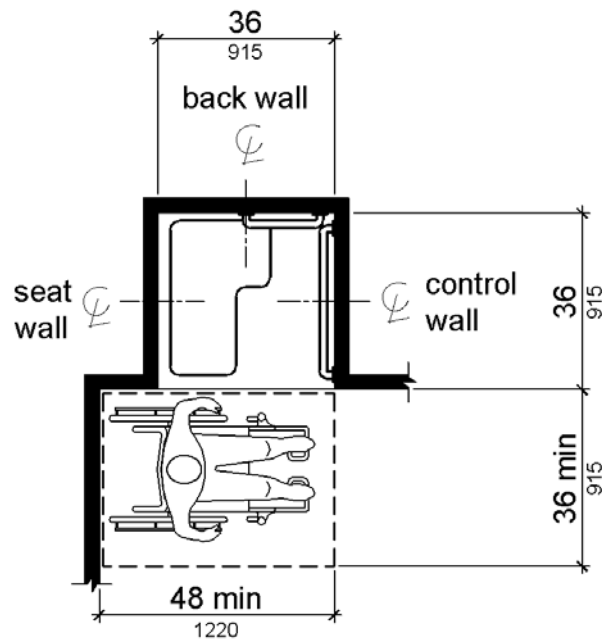

Note: inside finished dimensions measured at the center points of opposing sides

Yes No N/A

Standard roll-in type shower compartments shall be 30 inches wide minimum by 60 inches deep minimum clear inside dimensions measured at center points of opposing sides and shall have a 60 inches wide minimum entry on the face of the shower compartment.

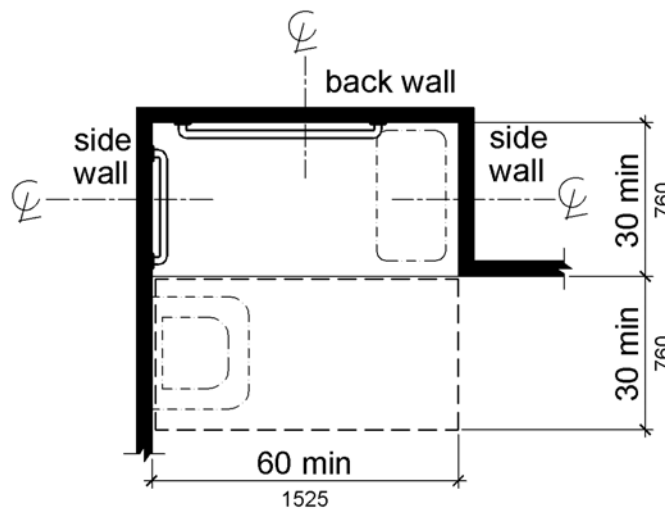

Note: inside finished dimensions measured at the center points of opposing sides

Restrooms

Yes No N/A
 Yes No N/A

Accessible restrooms are near the building entrance or program areas on each floor.
 If the mirror is over a lavatory or countertop, is the bottom edge of the reflecting surface no higher than 40 inches above the floor?

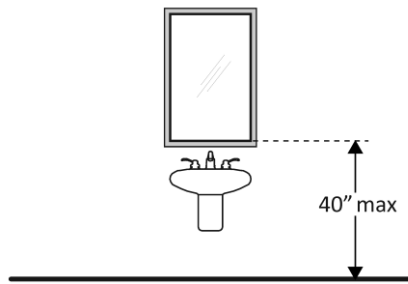

- Yes No N/A Doors have lever handles.
- Yes No N/A If not all toilet rooms are accessible, is there a sign at the accessible toilet room with the International Symbol of Accessibility?
- Yes No N/A Doors into restrooms are at least 32" wide.
- Yes No N/A Accessible restroom is large enough for wheelchair turnaround (60" minimum).
- Yes No N/A Staff doors are a minimum of 32" wide.
- Yes No N/A Grab bars are provided behind commode.

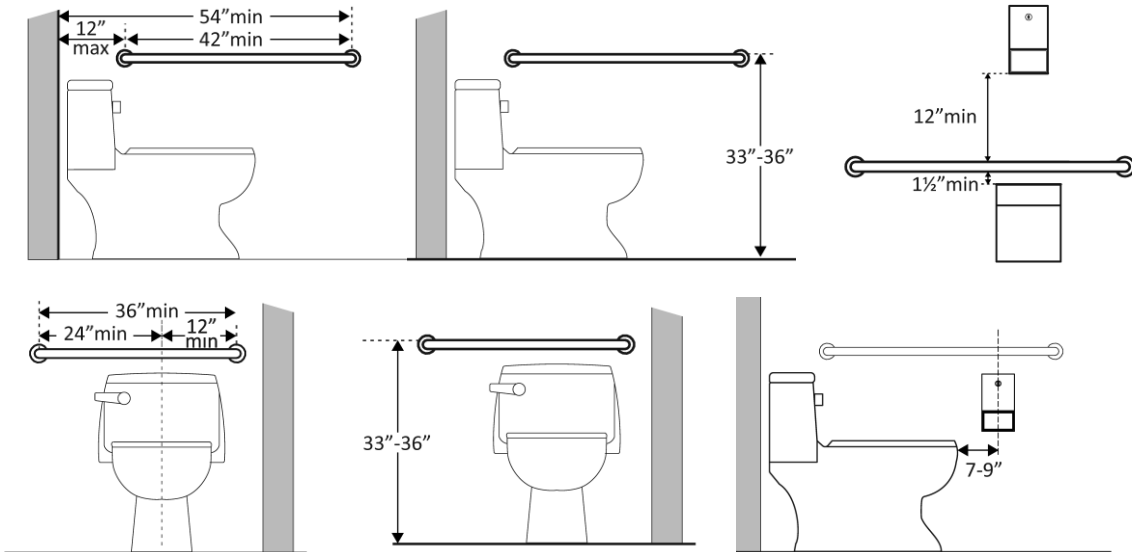

- Yes No N/A Sinks are at least 27" high with room for a wheelchair to roll under.

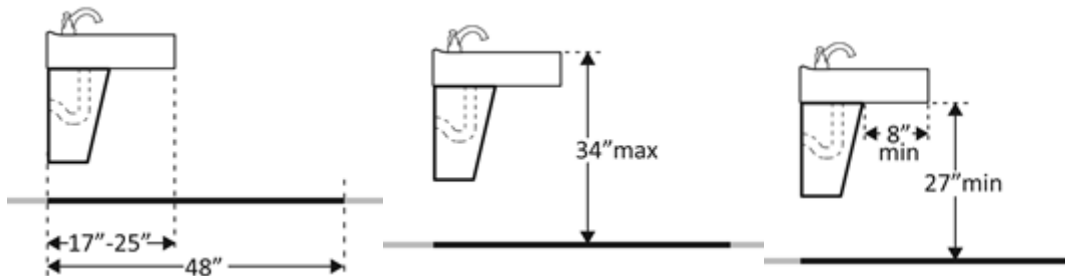

- Yes No N/A Are pipes below the lavatory insulated or otherwise configured to protect against contact?
- Yes No N/A Soap and towel dispensers and mirrors are no more than 48" from the floor (44" if above sink).

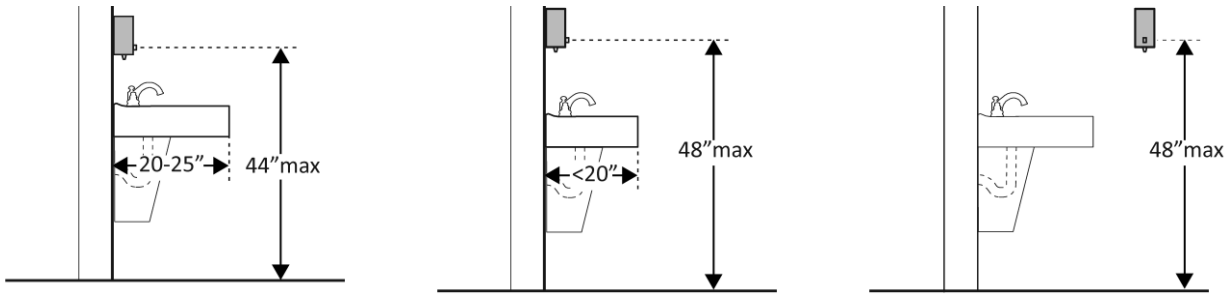

Yes No N/A There is a urinal placed no more than 15-17" above the floor.

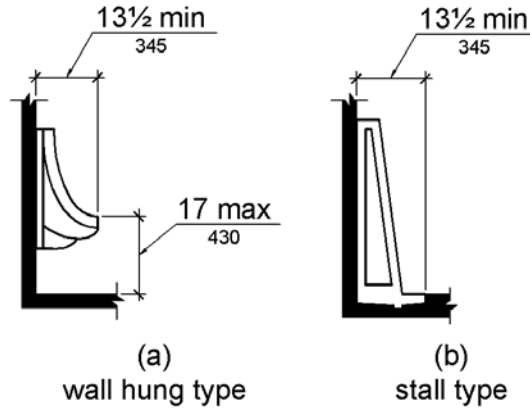

Elevators

- Yes No N/A Elevators are located within proximity to accessible travel path.
- Yes No N/A There is a clear door opening of at least 32".
- Yes No N/A There is adequate maneuvering space for wheelchairs.
- Yes No N/A Elevator controls are low enough (15" min - 54" max) to be reached from a wheelchair.
- Yes No N/A Elevator markings are in Braille.
- Yes No N/A Elevators provide audible signals.
- Yes No N/A Elevator interiors provide a turning area of 51" for wheelchairs.
- Yes No N/A Top elevator numbers are placed between 48"-54" from the floor.
- Yes No N/A Floor numbers and other information items are raised or in Braille for blind persons.
- Yes No N/A There is railing in the elevator cab.
- Yes No N/A Elevator stops exactly at the floor level.

Classroom Access

- Yes No N/A CTAE labs have station(s) modified to accommodate individuals with disabilities.

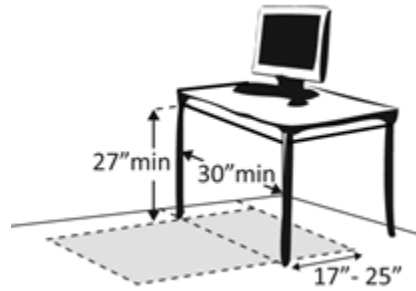

- Yes No N/A Music rooms are accessible without physical restriction.
- Yes No N/A Instruction areas are ADA accessible.
- Yes No N/A Elevated areas are ADA accessible.
- Yes No N/A Sunken or sloped areas are ADA accessible.
- Yes No N/A Computer labs have ADA accessible station(s).
- Yes No N/A Entrance doors have weight/lever handles with a minimum width of 32".
- Yes No N/A Greenhouse has accessible route of travel, modified work space, door entrance, accessible equipment and tools, and at least one work space with a firm non-graveled floor.
- Yes No N/A Drafting classroom has adjustable tables and appropriate work space.
- Yes No N/A AG and T & I classrooms have adjustable tables/work space.
- Yes No N/A Family and Consumer Science lab has accessible counters, work areas, sink, refrigerator are accessible. At least one oven range has front controls.
- Yes No N/A There is sound equipment in the gym/theater for hearing impaired individuals
- Yes No N/A Interior doors are easy to open (5 lbsf).
- Yes No N/A The travel path between tables, desk, and furniture is wide enough for wheelchairs (36").

APPENDIX D

Notice of Non-discrimination

The following sample notice of non-discrimination meets the minimum requirements of the regulations enforced by OCR/MOA [Title IX: 34 CFR 106.9; Section 504:34 CFR 104.8; Title IX: 34 CFR 106.8; Section 504:34 CFR 104.7(a)].

The (Name of Recipient/School District) does not discriminate on the basis of race, color, national origin, sex, disability, or age in its programs and activities and provides equal access to the Boy Scouts and other designated youth groups. The following person(s) has been designated to handle inquiries regarding the non-discrimination policies:

Name and Title (i.e. 504 Coordinator or Title IX Coordinator)
Address
Telephone Number
E-mail Address

Name and Title (i.e. 504 Coordinator or Title IX Coordinator)
Address
Telephone Number
E-mail Address

Annual Public Notice of Career and Technical Education Opportunities

OCR/MOA Guideline IV (O) requires recipients **to annually issue public notification** that all career and technical education opportunities will be offered without regard to race, color, religion, national origin, sex, age, or disability. Several requirements encompass an acceptable notice.

The notification must:

- Be made prior to the beginning of **each** school year.
- Advise students, parents/guardians, employees, and the general public of the policy of nondiscrimination.
- Contain an assurance that the lack of English language skills will not be a barrier to admission and participation in career and technical education programs.
- Be disseminated to communities of national origin minority persons with limited English language skills in their native language.
- Provide a brief summary of program offerings.
- Provide a brief summary of admissions criteria.
- Provide the name and title, office address and telephone number of the person(s) designated to coordinate Title IX, Section 504, and Age compliance.

Local newspapers, school newsletters, bulletins, memoranda, other publications, and other media are ways for providing this notification, as shown in the following examples.

APPENDIX E

SAMPLE 1

The (Everyday County/City School System) offers career and technical education programs at (Ironworks High School, Peterman Career Technical Center, Moosehead Middle School). These programs are designed to prepare youth for a broad range of employment and further education and are offered under the guidance of certified teachers. The following is a list of programs being offered this year and the criteria for admission.

<u>Program</u>	<u>Criteria for Admission</u>	Students Must:
Health Science Cosmetology		Be able to work in environment with various chemicals and hair care products.
Automotive Service Technology Horticulture		Be able to reach, bend, and lift 10 pounds Be able to work in environment with various pollens and allergens

All career and technical education programs follow the system's policies of nondiscrimination on the basis of race, color, religion, national origin, sex, age, and disability in all programs, services, activities, and employment. In addition, arrangements can be made to ensure that the lack of English language proficiency is not a barrier to admission or participation.

For general information about these programs, contact:

Name

Career and Technical Administrator

Address

Telephone Number

E-Mail Address

Inquiries regarding nondiscrimination policies should be directed to:

Name and Title

Address

Telephone Number

E-mail Address

Name and Title

Address

Telephone Number

E-mail Address

APPENDIX F

SAMPLE 2

Public Notice Concrete County Board of Education

The Concrete County School system offers the following career and technical education programs for all students regardless of race, color, national origin, including those with limited English proficiency, sex or disability in grades 9-12.

- Horticulture
- Cosmetology
- Culinary Arts
- Law and Public Safety
- Welding
- Automotive Service Technology
- Business/Marketing

Persons seeking further information concerning the career and technical education offerings and specific pre-requisite criteria should contact:

Mr. Ray GaDOE
Career Technical Administrator
333 Concrete Drive
Tomahawk, AL 00033
000-343-0000
E-mail Address

Inquiries regarding nondiscrimination policies should be directed to:

Name and Title
Address
Telephone Number
E-mail Address
Name and Title
Address
Telephone Number
E-mail Address

Introduction

The Department of Education's (ED) Office for Civil Rights (OCR) enforces several statutes that protect the rights of beneficiaries in programs or activities that receive financial assistance from ED. These laws prohibit discrimination on the basis of race, color, and national origin (Title VI of the *Civil Rights Act of 1964*), sex (Title IX of the *Education Amendments of 1972*), disability (Section 504 of the *Rehabilitation Act of 1973*), and age (*Age Discrimination Act of 1975*). OCR also has enforcement responsibilities under Title II of the *Americans with Disabilities Act*, which prohibits state and local governments from discriminating on the basis of disability. In addition, OCR enforces the *Boy Scouts of America Equal Access Act* which addresses equal access to meet on school premises or in school facilities for the Boy Scouts of America and other designated youth groups.

This fact sheet explains the requirements for schools, colleges, and state and local governments that receive federal funds to issue notices of non-discrimination, clarifies the information that they should include in their non-discrimination notices, and provides a sample notice of non-discrimination. This fact sheet is designed to assist education institutions in establishing a notice of non-discrimination that meets the requirements of the applicable regulations.

Notice of Non-discrimination Requirements

The regulations implementing Title VI, Title IX, Section 504, the *Age Discrimination Act*, and the *Boy Scouts Act* contain requirements

for recipients to issue notices of non-discrimination. (See 34 C.F.R. Sections 100.6(d), 106.9, 104.8, 110.25, and 108.9, respectively.) The Title II regulation also contains a notice requirement that applies to all entities of state or local government, whether or not they receive federal financial assistance. (See 28 C.F.R. Section 35.106.)

These regulations require that recipients notify students, parents and others that they do not discriminate on the basis of race, color, national origin, sex, disability, and age, and, if applicable, that they provide equal access to the Boy Scouts of America and other designated youth groups. However, these regulations contain minor differences relating to the required content of recipient notices of non-discrimination and the methods used to publish them.

The Title VI regulation requires schools and colleges to notify students and others of the regulatory provisions in a manner that a responsible ED official would find necessary to tell students of their protections against discrimination under the statute and regulation.

The Boy Scouts Act regulation incorporates the Title VI regulatory provision concerning notice of non-discrimination. Public elementary and secondary schools and local and state educational agencies that receive funds made available through ED must make available information regarding the provisions of the Boy Scouts Act. This information must be made available in a manner that a responsible ED official would find necessary to inform people of the protections provided under the Boy Scouts Act and its regulation. Entities other than public elementary and secondary schools

and local and state educational agencies that receive funds made available through ED need not provide this notice, as the Boy Scouts Act does not apply to them.

The Title IX and the Section 504 regulations both contain more detailed requirements that specify the information that must be included in a notice of non-discrimination. These regulations also require recipients to designate at least one employee to coordinate efforts to comply with and carry out responsibilities.

The Title IX regulation requires schools and colleges to implement specific and continuing steps to inform students and others of the protections against discrimination on the basis of sex. The notification must state that the requirement of non-discrimination in educational programs and activities extends to employment and admission. It also must say that questions about Title IX may be referred to the employee designated to coordinate Title IX compliance or to the assistant secretary for civil rights. Schools are required to include the name, address, and telephone number of the designated coordinator in their notifications.

The Section 504 regulation requires that schools and colleges employing 15 or more persons implement appropriate, continuing steps to notify students and others that the school does not discriminate on the basis of disability in violation of the statute and regulation. The notification must state, where appropriate, that the school or college does not discriminate in admission, treatment, or access to its programs or activities. The notification also must state that the school or college does not discriminate in employment in its programs or activities. The employee designated to

coordinate compliance with the Section 504 regulation must be identified in the notification.

The Title II regulation requires that a public entity generally make information regarding the provisions of Title II available to applicants, participants and other interested persons in such a manner as the head of the entity finds necessary to apprise such persons of the protections against discrimination under the Americans with Disabilities Act. The regulation implementing the Age Discrimination Act requires a school or college to notify its students and applicants, in a continuing manner, of information regarding the provisions of the act and these regulations. The notice must identify the compliance coordinator by name or title, address, and telephone number.

Methods of Notification

In accordance with the Title IX and Section 504 regulations, notification may include posting information notices, publishing in local newspapers, publishing in newspapers and magazines operated by the school or its students, publishing in alumni or alumni newspapers or magazines, or distributing memoranda or other written communications to students and employees. In addition, recipients are required to include a statement of nondiscriminatory policy in any bulletins, announcements, publications, catalogs, application forms, or other recruitment materials that are made available to participants, students, applicants, or employees. As noted in the pertinent Section 504 regulatory provision, schools may meet this requirement either by including appropriate inserts in existing materials and publications

or by revising and reprinting the materials and publications.

Neither the Title VI regulation, the *Boy Scouts Act* regulation, the *Age Discrimination Act* regulation, nor the Title II regulation specifies the methods to be used by recipients in publishing notices of non-discrimination.

Combined Requirements

OCR recognizes the variations among the regulations governing notice requirements and understands that schools and colleges may wish to use one statement to comply with all requirements of the regulations implementing Title VI, Title IX, Section 504, the *Age Discrimination Act*, and, if applicable, the *Boy Scouts Act*. Public institutions also may wish to include Title II of the *Americans with Disabilities Act* in their statement. OCR encourages one combined notice for the regulations.

A combined non-discrimination notice should contain two basic elements: (1) a statement of non-discrimination that specifies the basis for non-discrimination; and (2) identification by name or title, address, and telephone number of the employee or employees responsible for coordinating the compliance efforts.

The regulations do not require that a recipient identify the pertinent regulations by title. Please see the sample notice at the end of this pamphlet.

The Title IX regulation requires a recipient to provide the name of the person responsible for its compliance effort in addition to the address and telephone number where that person may be contacted. However, because OCR recognizes that the inclusion of a person's name

in a non-discrimination notice may result in an overly burdensome requirement to republish the notice if a person leaves the coordinator position, it is acceptable for a recipient to identify its coordinator only through a position title.

The Section 504 regulation does not require a recipient to include the address or telephone number of the responsible employee assigned to coordinate its compliance efforts. However, OCR considers that identifying the responsible employee without information on how to contact that person does not constitute an effective notice. An acceptable non-discrimination notice should provide information on how to contact the responsible employee.

Compliance with the notification requirements of Section 504 will also generally satisfy the notification requirements of Title II for state and local governments.

Although the Section 504 and Title IX regulations state that schools and colleges, where appropriate, shall specify non-discrimination in the areas of admission and employment, a general statement indicating non-discrimination in all programs is acceptable.

The Title IX regulation indicates that inquiries concerning the application of the Title IX regulation may be referred to the coordinator or to the assistant secretary for civil rights. An acceptable notice may include the names and titles of either one or both individuals.

However, since the Section 504 regulation requires identification of a coordinator, a combined non-discrimination notice should

include the name and/or title of the responsible employee. If a recipient designates two different people to coordinate compliance with Section 504 and Title IX, both names or titles should be included in the notice.

Sample Notice of Non-discrimination

The following sample notice of non-discrimination meets the minimum requirements of the regulations enforced by OCR:

The (Name of Recipient) does not discriminate on the basis of race, color, national origin, sex, disability, or age in its programs and activities and provides equal access to the Boy Scouts and other designated youth groups.¹ The following person has been designated to handle inquiries regarding the non-discrimination policies:

Name and/or Title
Address
Telephone No.
Name and/or Title²
Address
Telephone No.

For further information on notice of non-discrimination, visit <http://wdetoolcp01.ed.gov/CFAPPS/OCR/contactus.cfm> for the address and phone number of the office that serves your area, or call 1-800-421-3481.



Notice of

NON-DISCRIMINATION

August 2010

U.S. Department of Education
Office for Civil Rights
Washington, DC 20202-1100

¹ Only public elementary or secondary schools or local or state educational agencies that receive funds made available through the Department of Education should include the words "and provide equal access to the Boy Scouts and other designated youth groups."

² For use whenever than one official has been designated to coordinate civil rights compliance.

APPENDIX H

FY2021 Georgia OCR (Office for Civil Rights)/MOA (Methods of Administration) Compliance Reviews

Frequently Asked Questions

Q. What are the federal civil rights laws, regulations and guidelines with which CTAE program must comply?

Federal law requires that all school districts receiving federal funding support from the U.S. Education Department, and providing career, technical and agricultural education programs shall comply with:

THE CIVIL RIGHTS ACT OF 1964, TITLE VI:

No person in the United States shall, on the ground of race, color, or national origin, be excluded from, be denied the benefits of, or be subjected to discrimination under any program or activity receiving Federal financial assistance.

THE REHABILITATION ACT OF 1973, SECTION 504:

No otherwise qualified handicapped individual...shall, solely by reason of his or her handicap, be excluded from the participation in, be denied the benefits of, or be subjected to discrimination under any program or activity receiving Federal financial assistance.

THE EDUCATION AMENDMENTS OF 1972, TITLE IX:

No person...shall, on the basis of sex, be excluded from participation in, be denied the benefits of, or be subjected to discrimination under any education program or activity receiving Federal financial assistance.

THE AMERICAN WITH DISABILITIES EDUCATION ACT OF 1990, TITLE II:

An act to establish a clear and comprehensive prohibition of discrimination on the basis of disability.

Vocational Education Program Guidelines for Eliminating Discrimination and Denial of Services on the Basis of Race, Color, National Origin, Sex, and Handicap. Federal Register, March 21, 1979.

Q. What do I need to do, if my local system is selected?

A. School districts selected for an onsite civil rights review of CTAE programs will be notified at least 30 days in advance. The facilities and documents to be reviewed, as well as an explanation of the onsite process will be provided in a detailed notification letter. The notification will be mailed to the school superintendent and the CTAE director. Agencies that have implemented a self assessment process according to guidance and materials provided by CTAE review team should have in place the necessary documents and information.

Q. What will happen during the review process and after?

A. The review team will conduct an entrance meeting with school superintendent, CTAE director and other staff. Afterwards the review team will review CTAE programs, school facilities, examine the documents provided, interview staff and students, and conduct an exit meeting to discuss “findings”. Within 45 days, a Letter of Findings (LOF) will be mailed to the district superintendent and the CTAE supervisor. The local agency is required to produce a voluntary compliance plan (VCP) to correct all violations. The review team will assist the school(s) in resolving any violations within a reasonable period of time, in order to finalize the review process.

Q. What facilities will be reviewed?

A. The review team will review all instructional programs, as well as areas where students participate in general programs of instruction. The purpose is to assure that CTAE programs and other activities are accessible to, and usable by, persons with disabilities, and that equal educational opportunity is provided. The review may include libraries, cafeterias, resource rooms, counseling and administrative offices, lavatories, parking areas, building entrances, hallways, as well as CTAE program areas and other areas as determined. Please note that the federal financial assistance is not limited to receipt of Carl Perkins funding. It includes *any* funding from the U. S. Department of Education.

Q. How are school districts selected for onsite reviews?

A state targeting plan, approved by the federal Office for Civil Rights, identifies the information and procedures used to select systems for review. A copy of this targeting plan is available for review upon request. Contact Dr. Ray Anukam at ranukam@doe.k12.ga.us if you have questions.

To ensure equitable distribution of federal vocation education funds and to encourage high-quality Career, Technical and Agricultural Education (CTAE) programs, the U.S. Department of Education Office for Civil Rights requires the local agency to conduct compliance reviews of the state’s CTAE programs. “The mission of the U.S. Department of Education Office for Civil Rights is to ensure equal access to education and to promote educational excellence throughout the nation through vigorous enforcement of civil rights.”

School districts have been selected for on-site review and technical assistance based on a federally approved targeting plan. Ongoing compliance with civil rights statutes is required by the U.S. Department of Education Office for Civil Rights, regardless of whether your school district receives an onsite review. Federal civil rights regulations and guidelines can help us to provide each student with greater opportunities to achieve high academic standards, and to eliminate the achievement gap at state and local levels.

WHAT EXHIBITS ARE TO BE PROVIDED AT THE ON-SITE REVIEW?

The following documents or items should be provided in the OCR/MOA team meeting room. These documents will need to be retained by the compliance review team at the end of the site visit. They should be inserted into a file folder system and referenced as noted below. If you provide the requested items below as scanned documents when completing the Self Assessment, place a note to that effect in the folder. It is not necessary to provide the requested information again.

I Administrative Compliance

- A copy of the system BOE manual or website address where BOE policies are found.

II Site Location and Student Eligibility

- A copy of the Master Schedule for each high school facility
- A campus map of each school site which offers CTAE instruction. (highlight and identify classrooms/labs)

III Recruitment Issues

- Any CTAE area recruiting materials, brochures, flyers, videos, power points and any other materials used in the promotion of CTAE. (provide original copies of these if available)

IV Admissions Issues

- A copy of the Course Description Booklet
- A copy of the Student Handbook

V Student Financial Assistance Issues

- Copies of scholarship announcements
- A list of local scholarship awards and identification of recipients: male/female, race and national origin (LEP). (Need up to three years of information on this.)

VI Counseling Issues

- Copies of all career assessments used with students and timeline for their administration
- Copies of career-related brochures, newsletters, flyers from the counseling department, etc.

VII Services for Student with Disabilities

- Copies of the process and materials used to identify handicapped/special needs students (if personal records are copied, blacken the name of the student)

VIII 504/ADA Accessibility Issues

- See Checklist # 3, which follows this section.

IX Comparable Facilities Issues

- (N/A - observation of the facilities will be made by the compliance team)

X Work Study/Apprenticeship

- Copies of any WBL Training Applications
- Copies of any Employer Training Agreements
- Enrollment data: male/female, LEP, Disable, Black/White/Hispanic (for the entire program)

XI Employment Issues

- Copies of Job Postings for recent Certified and Classified staff position
- Copies of position recruitment advertisements placed in newspapers, periodicals etc.
- Copies of all Employment Application forms (system wide)
- A list of organizations/agencies where Job Announcements appear
- A copy of the District Affirmative Action Plan (if available)
- Copies of District staff recruiting materials (originals or photocopies)
- Copy of the Staff Handbook

APPENDIX I

**Georgia Department of Education, CTAE Division Office for Civil Rights
Voluntary Compliance Plan (VCP)**

ranukam@doe.k12.ga.us

404-657-6589

DATE

SCHOOL

DISTRICT NAME/NUMBER

*SUPERINTENDENT (signature)

E-MAIL

*SUPERINTENDENT (print name)

TELEPHONE#

FAX#

VIOLATIONS	CORRECTIVE ACTION	PERSON RESPONSIBLE	DATE TO INITIATE	VERIFICATION (pictures, meeting minutes, publications, invoices, materials)Note who completed and the date of verification.	TARGET COMPLETION DATE

***NOTE:** An electronic PDF copy must be emailed with the Superintendent's signature (plan will not be accepted without the Superintendent's signature) to Lplan@doe.k12.ga.us.

APPENDIX J

SECOND FLOOR

SALEM HIGH SCHOOL
3551 Underwood Road
Conyers, GA 30013

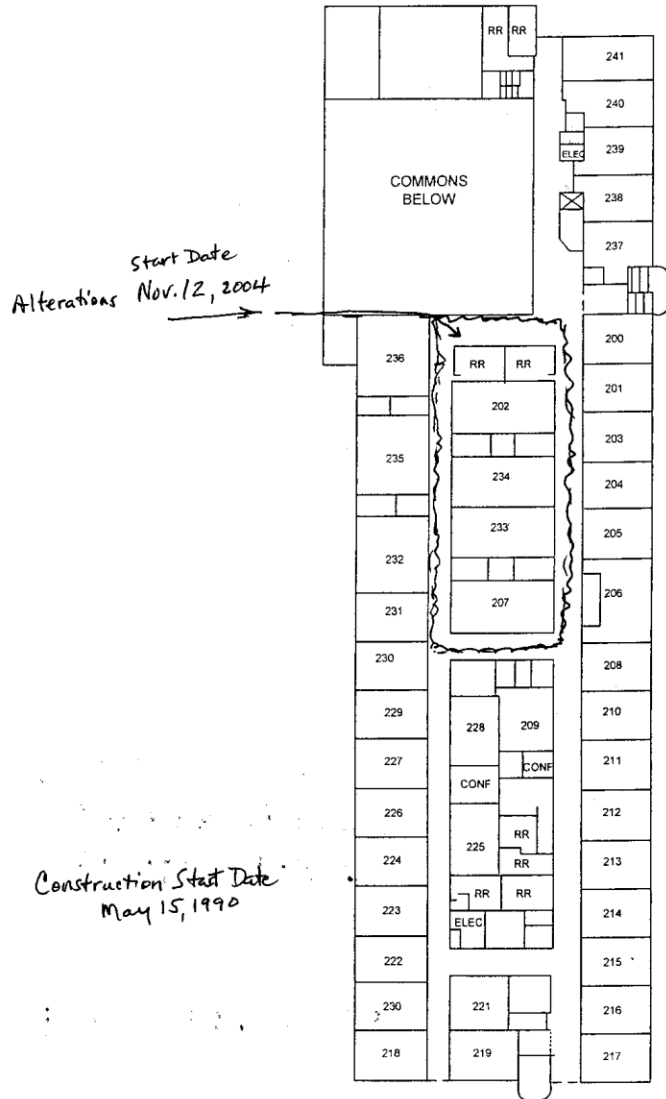

SAMPLE of
How to mark your
facilities floorplan
with construction
start dates or
alteration start dates.
*Not the year the
School opened!*

ROOM NUMBERS

APPENDIX K



**FY2021 Office of Civil Rights (OCR)/Methods of Administration (MOA)
On-Site Review
Student and Instructor Demographics Form**

System Name:

High School Name:

Review Date:

CTAE Administrator Name:

Student Demographics

Demographic Description	Total Number	Overall Percentage
American Indian		
Asian or Pacific Island		
Black, not Hispanic		
Hispanic		
White, not Hispanic		
Other		

Instructor Demographics

Demographic Description	Total Number	Overall Percentage
American Indian		
Asian or Pacific Island		
Black, not Hispanic		
Hispanic		
White, not Hispanic		
Other		

Special Demographics

Demographic Description	Total Number	Overall Percentage
Students with Disabilities		
English Learners (EL)		

